

Gesamtdicke: 100

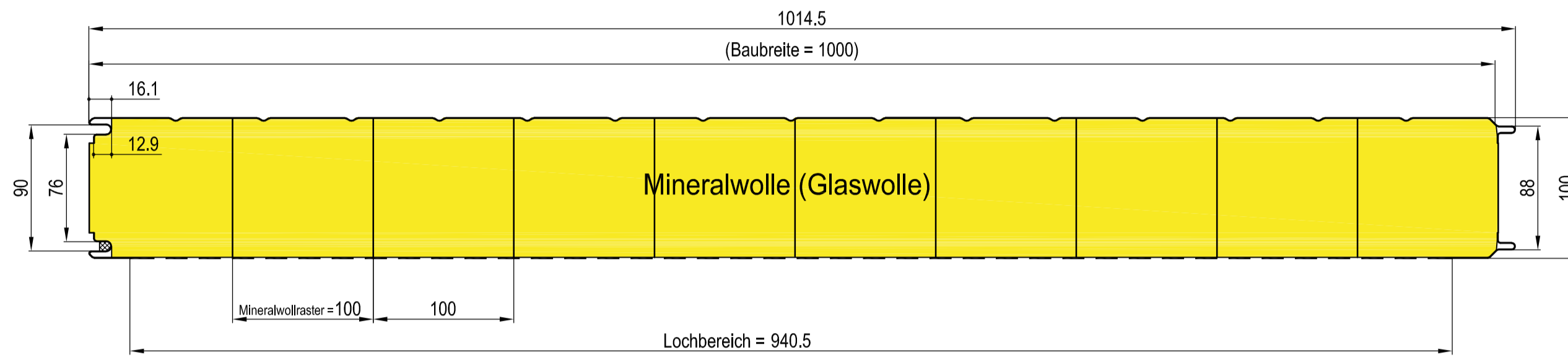

Gesamtdicke: 120

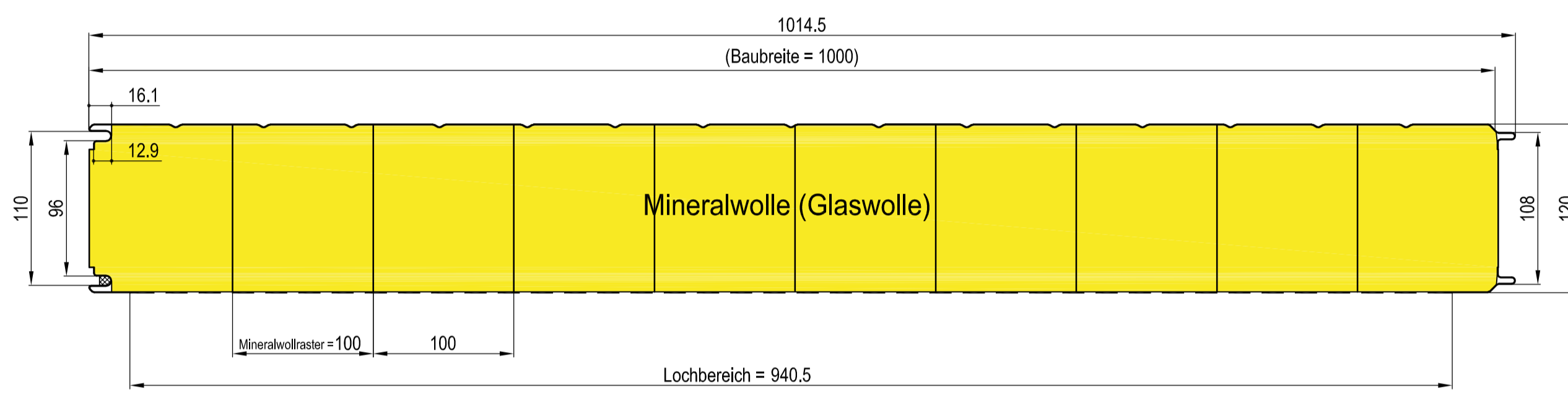

Gesamtdicke: 150

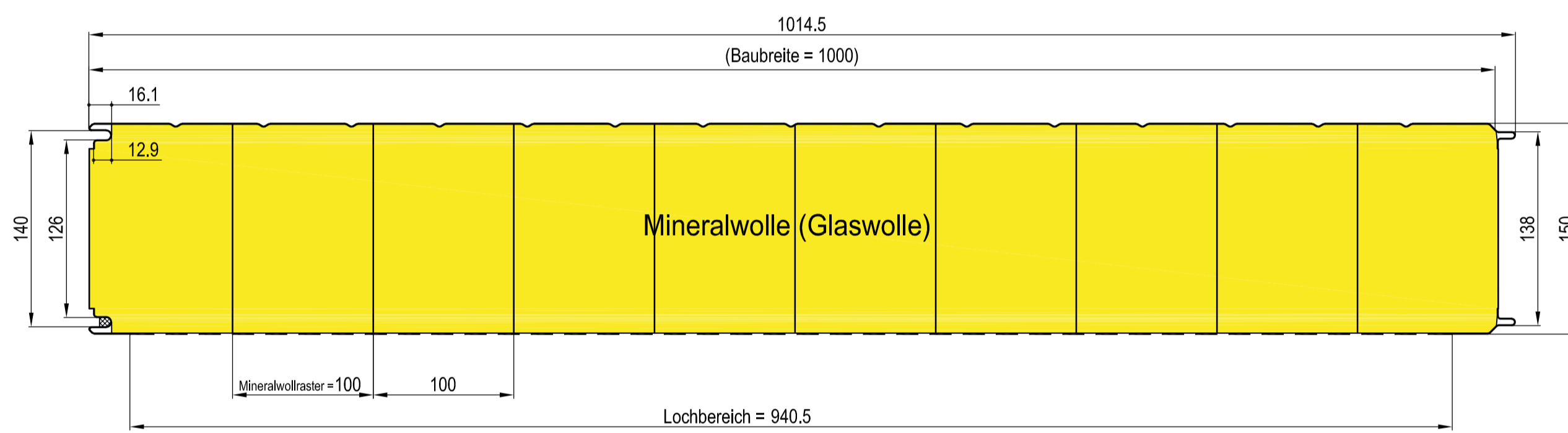

Gesamtdicke: 200

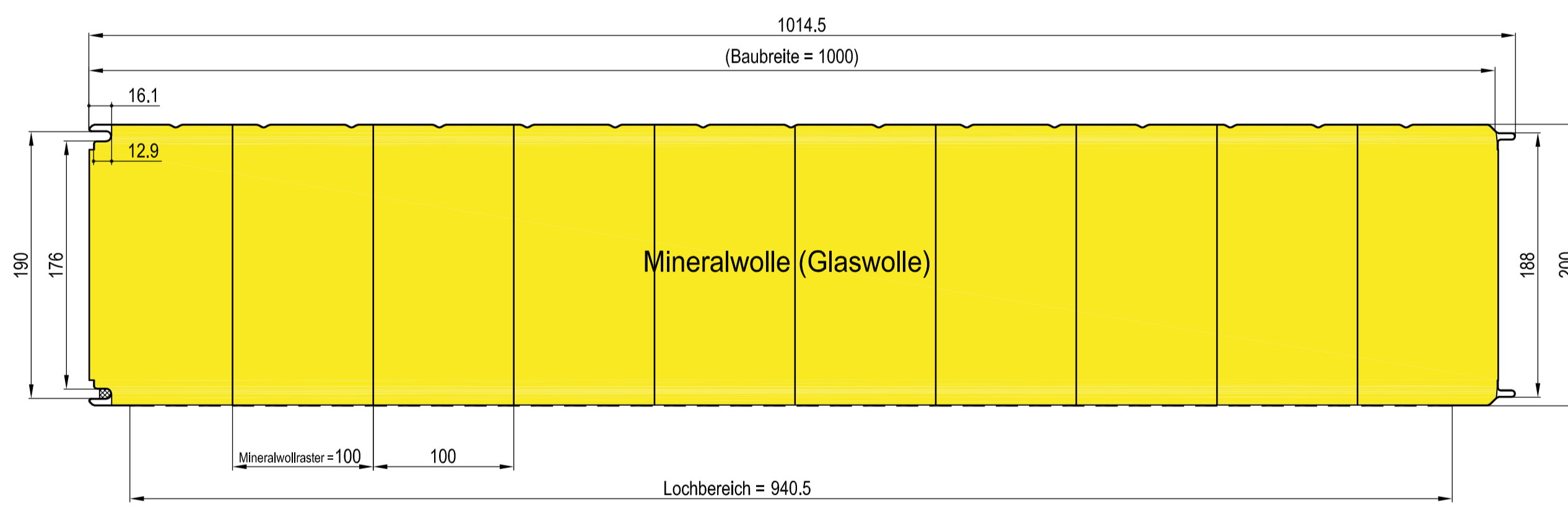

Gesamtdicke: 240

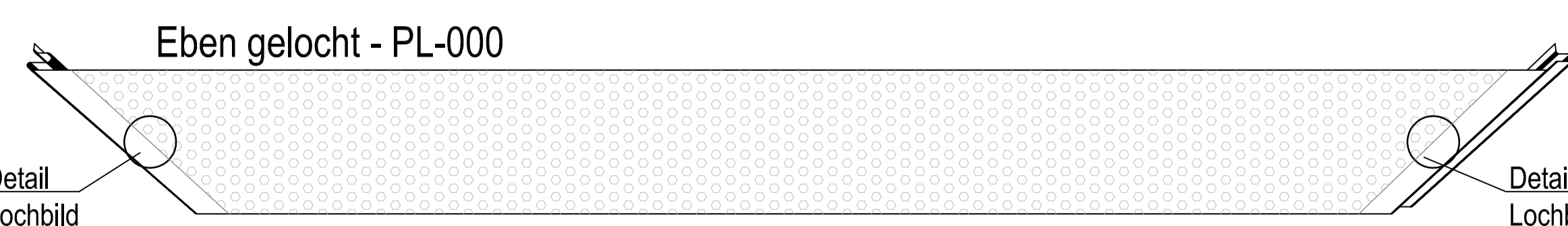
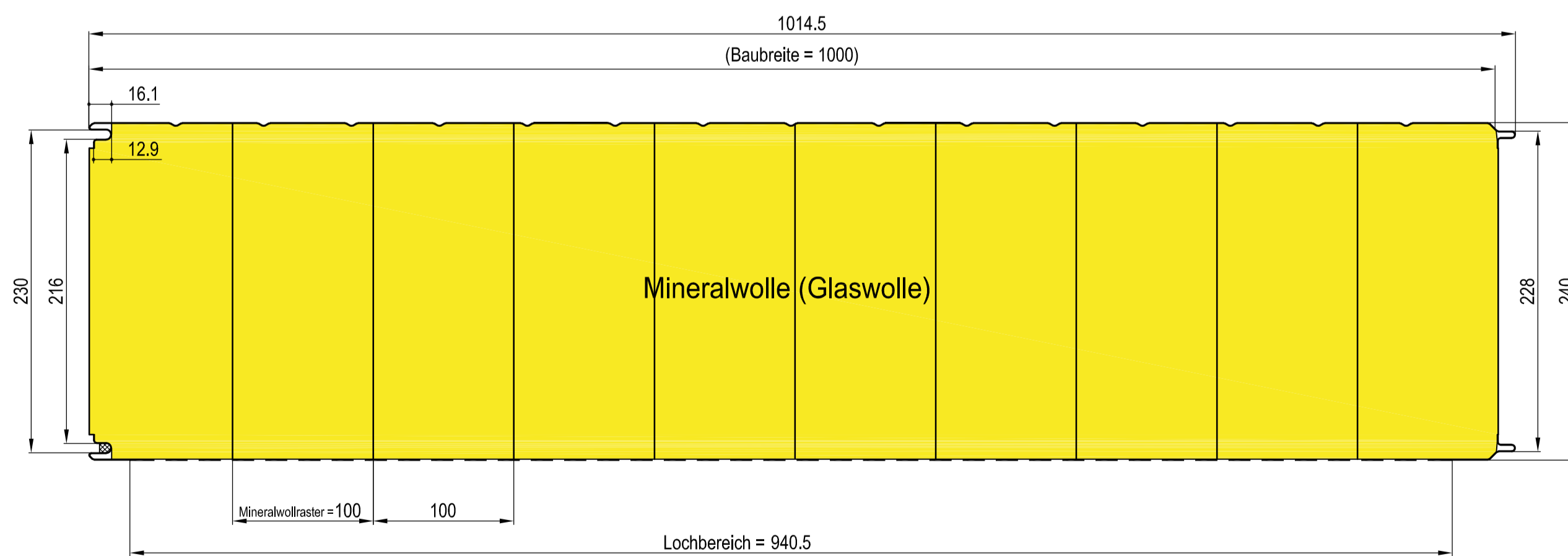

Detail

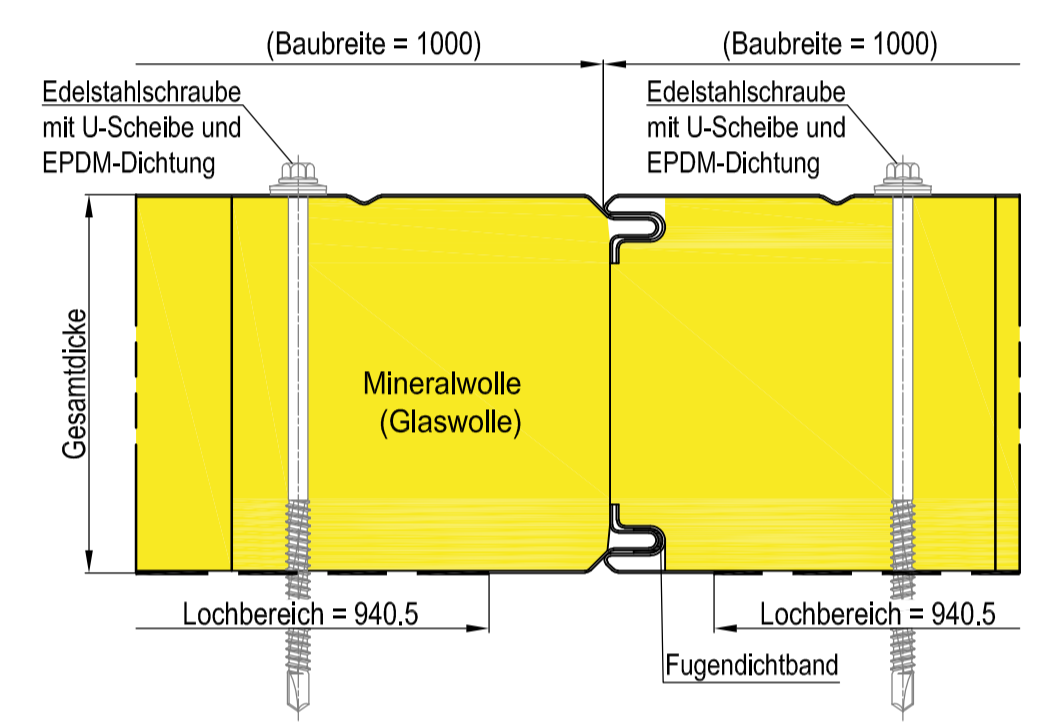

Detail Lochbild

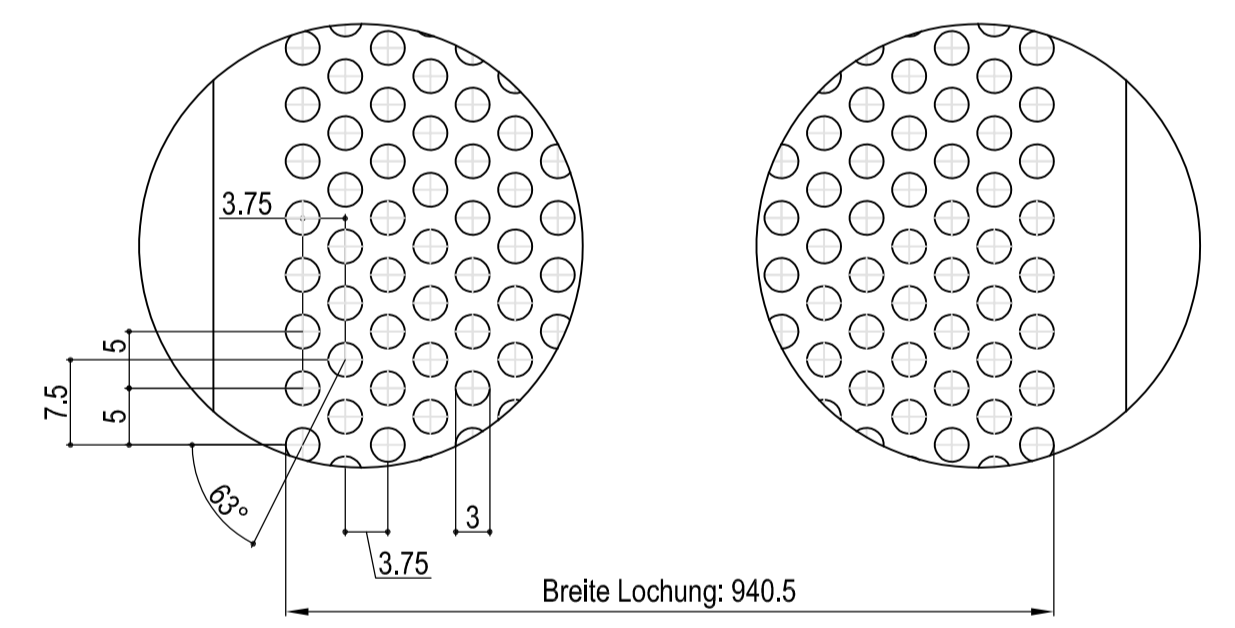

Es gelten die Toleranzen gemäß DIN EN 14509.

		Metecno Baustysteme GmbH		Maßstab	o. M.	Position	Menge
		Am Amselberg 1					
		99444 Blankenhain		Zeichnungs-Nr. 12-A			
01	Einheitsgröße 240mm ergibt	01.06.2017	ZB C.	Datum	Name	Metfiber® ECO Wand Sound	
				Bearb.	ZB Cramer	Sandwich - Wandelement mit Dämmkern aus	
				Freig.	Fr. Graf	Mineralwolle (Glaswolle)	
				Norm			
				zust. Sachbearbeiter:	R. Bräunel		
				metecno			
				Metecno Baustysteme GmbH			
Zust.	Änderung	Datum	Name				