

Kern- / Gesamtdicke: 60 / 98

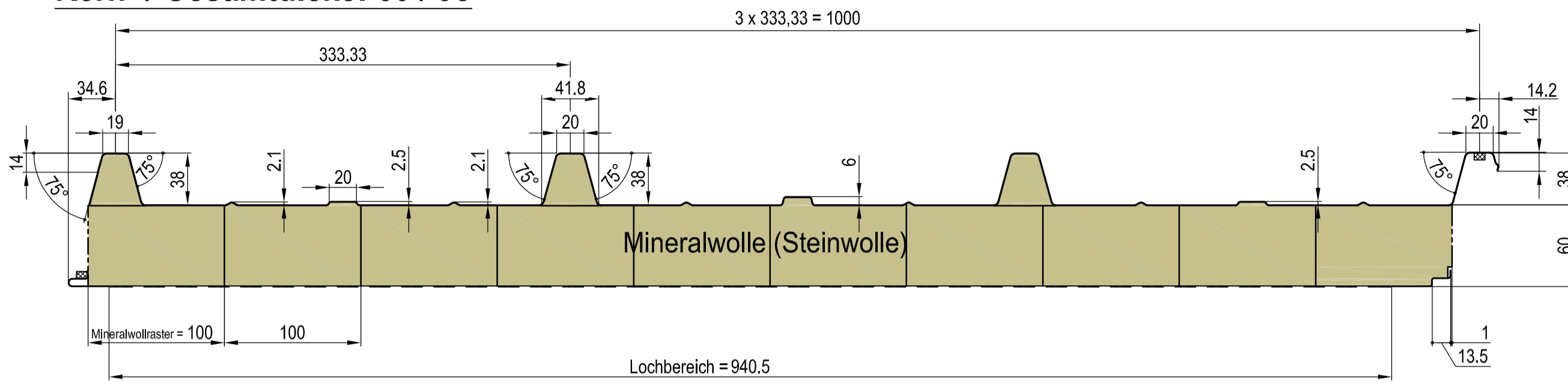

Kern- / Gesamtdicke: 80 / 118

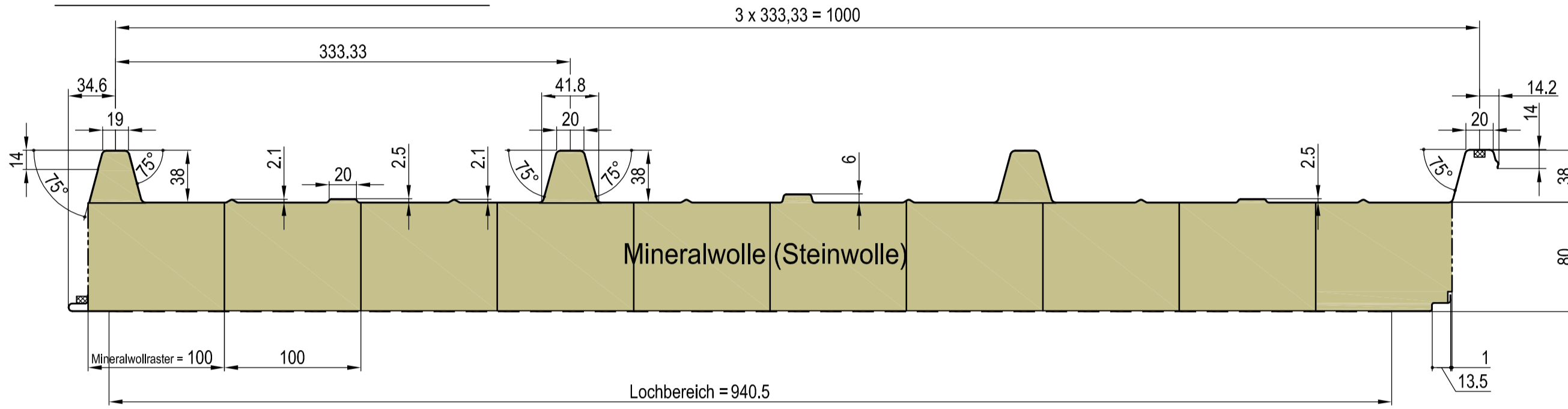

Kern- / Gesamtdicke: 100 / 138

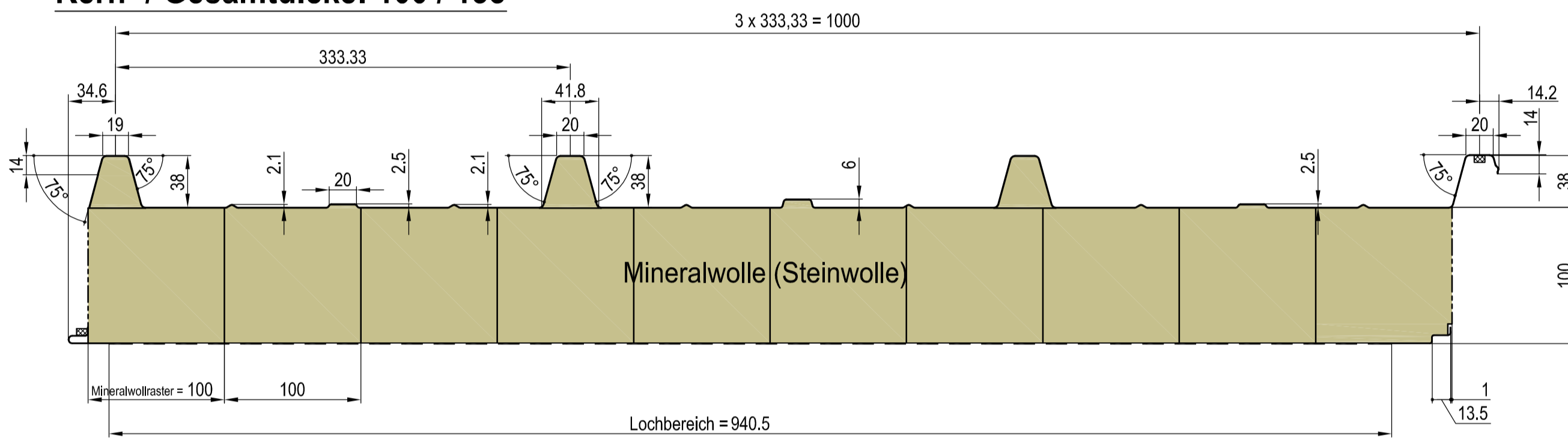

Kern- / Gesamtdicke: 120 / 158

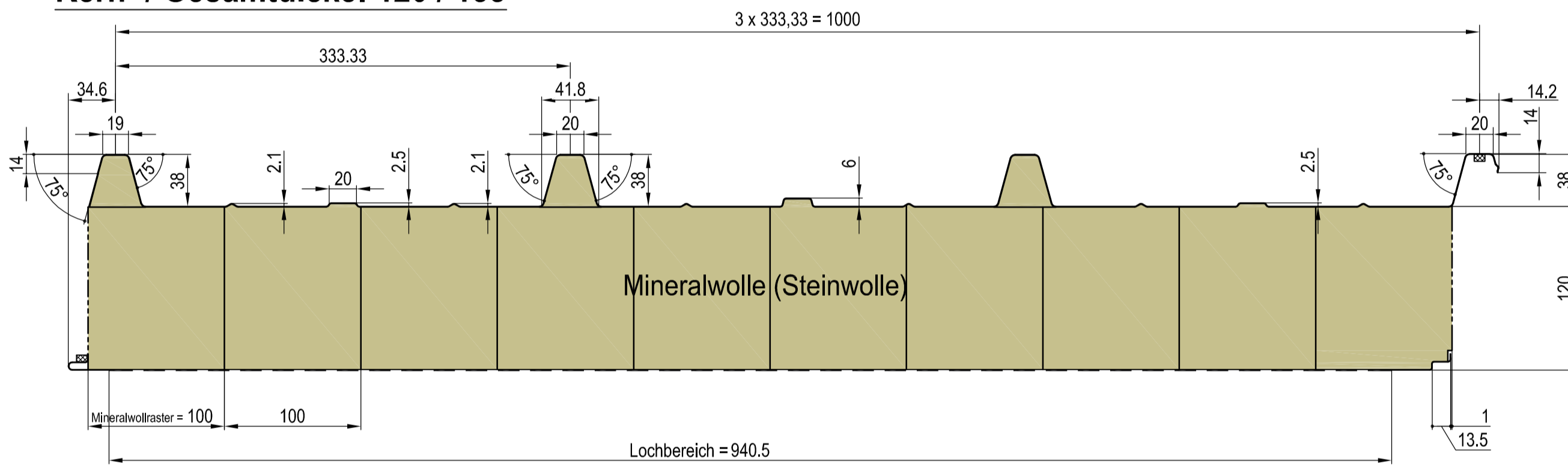

Kern- / Gesamtdicke: 150 / 188

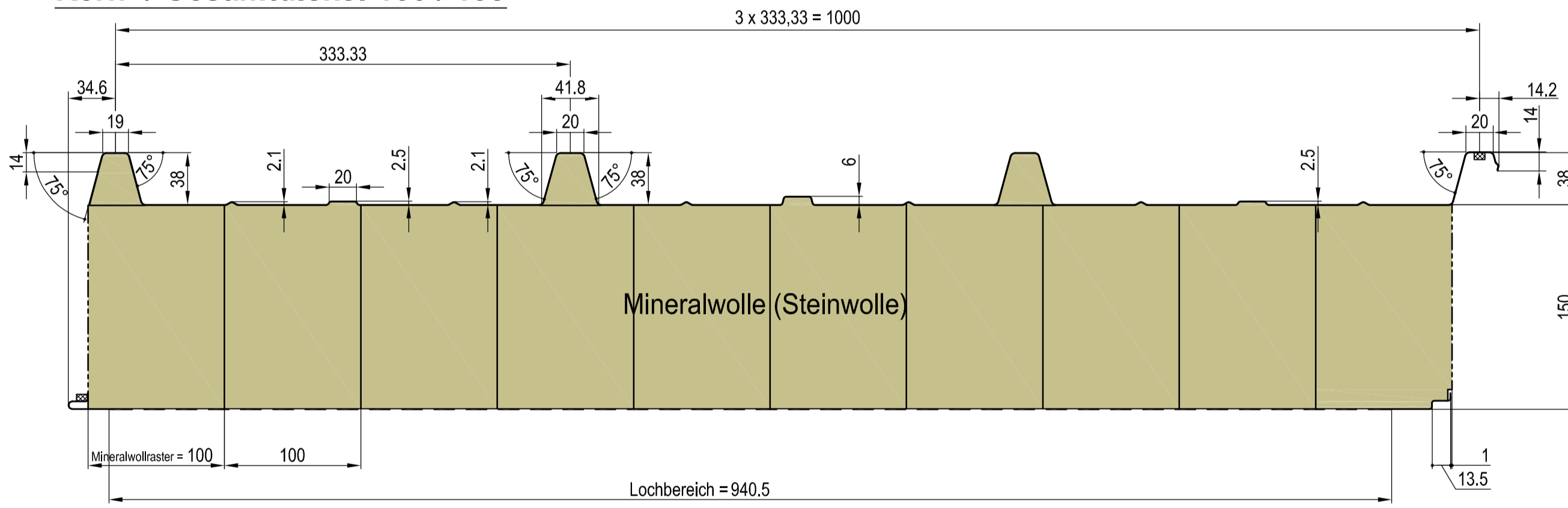

Kern- / Gesamtdicke: 200 / 238

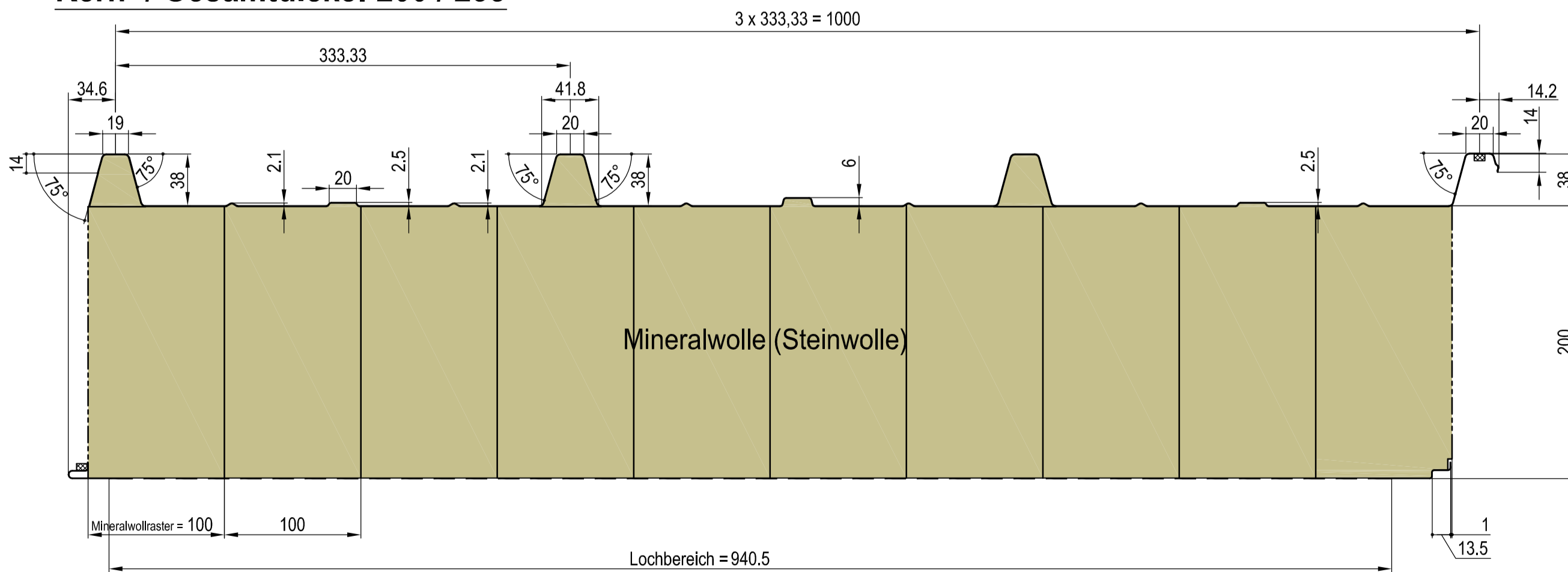

Eben gelocht - PL-000

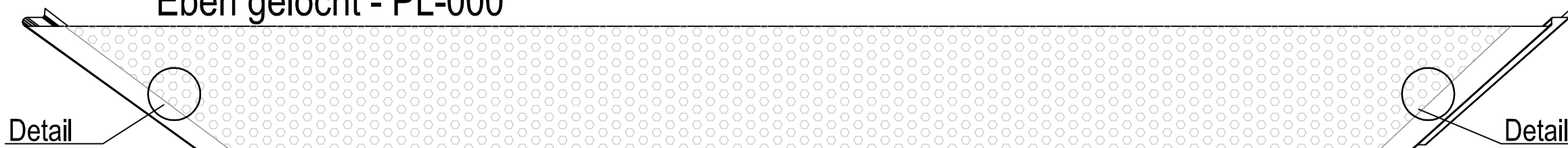

Detail Lochbild

Detail Lochbild

Detail Hochsicke

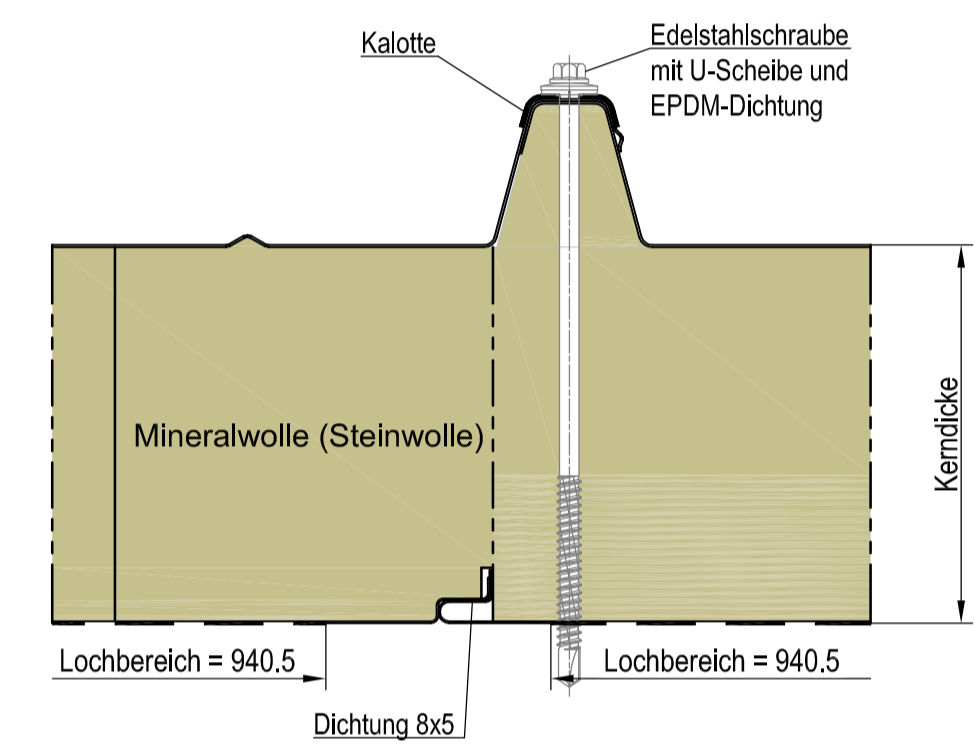

Detail Tiefsicke

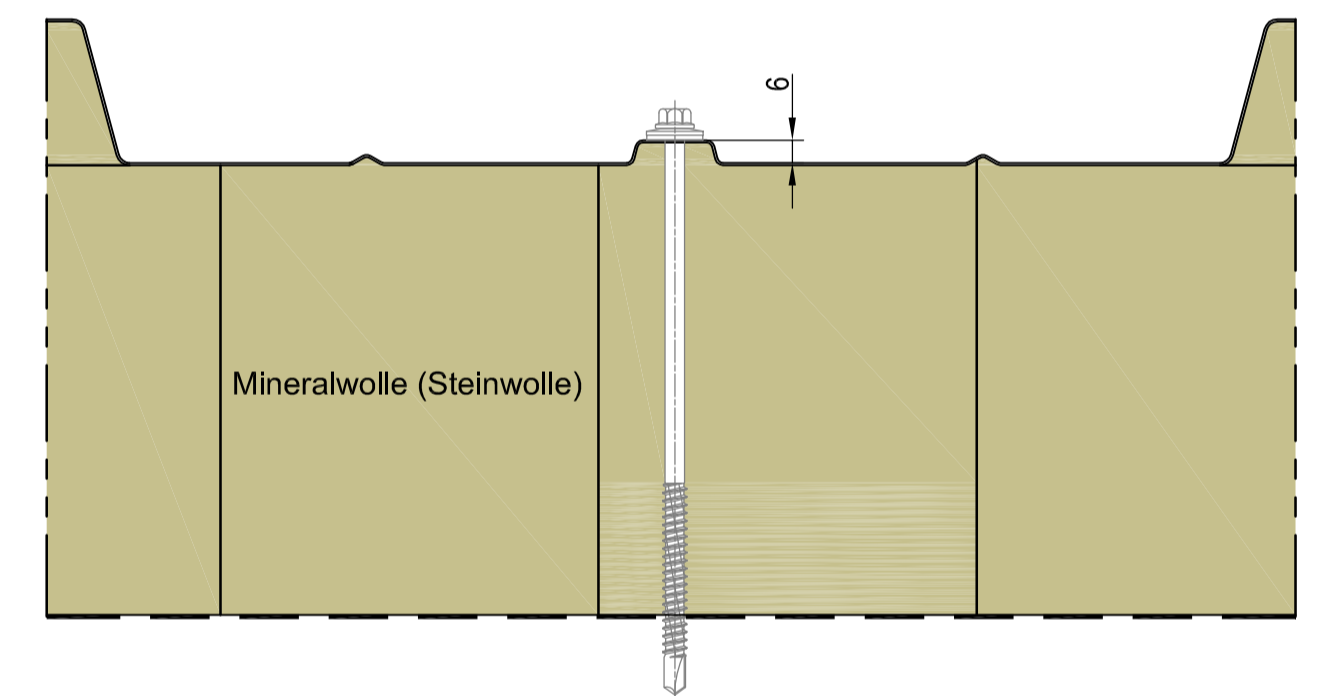

Detail Lochbild

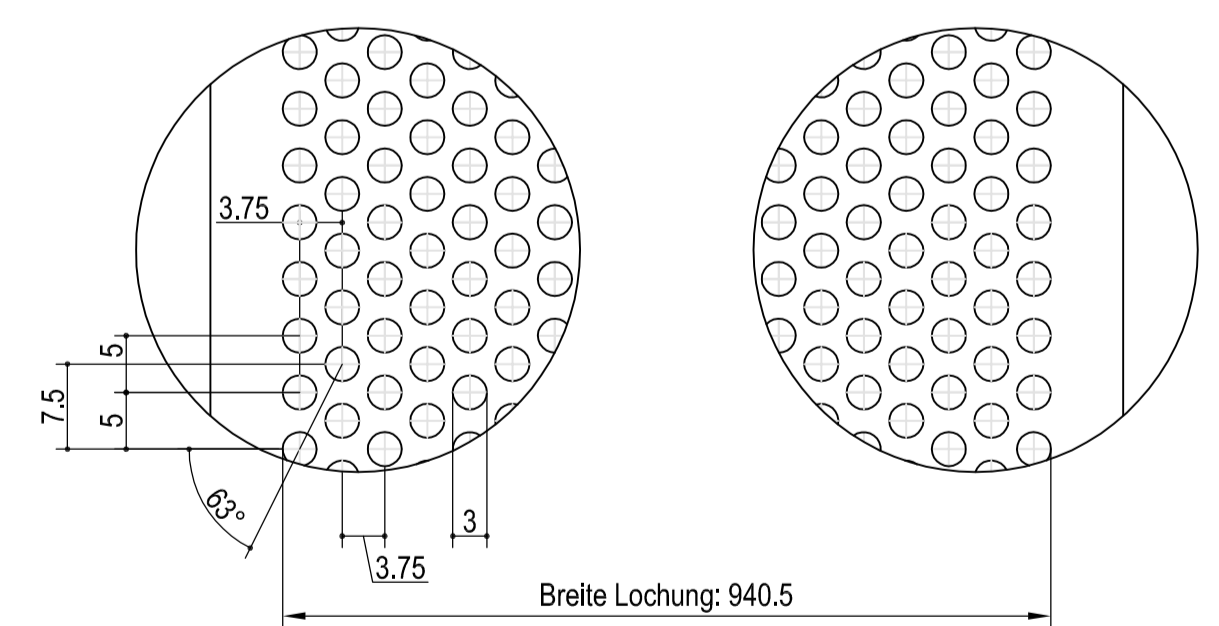

Es gelten die Toleranzen gemäß DIN EN 14506.

Metecno Baustysteme GmbH		Maßstab	o. M.	Position	Menge
Am Amselberg 1					
99444 Blankenhain		Zeichnungs-Nr. 03-A			
Bearb.	17.03.14	Name		Hipertec - Dach - Sound	
Zeich.	17.03.14	ZB Cramer		Sandwich - Dachelement mit Dämmkern aus	
		Fr. Graf		Mineralwolle (Steinwolle)	
		zust. Sachbearbeiter: R. Bräunel		HTDS	
		metecno		Metecno Baustysteme GmbH	
Zust.	Änderung	Datum	Name		