

**Gesamtdicke: 100**

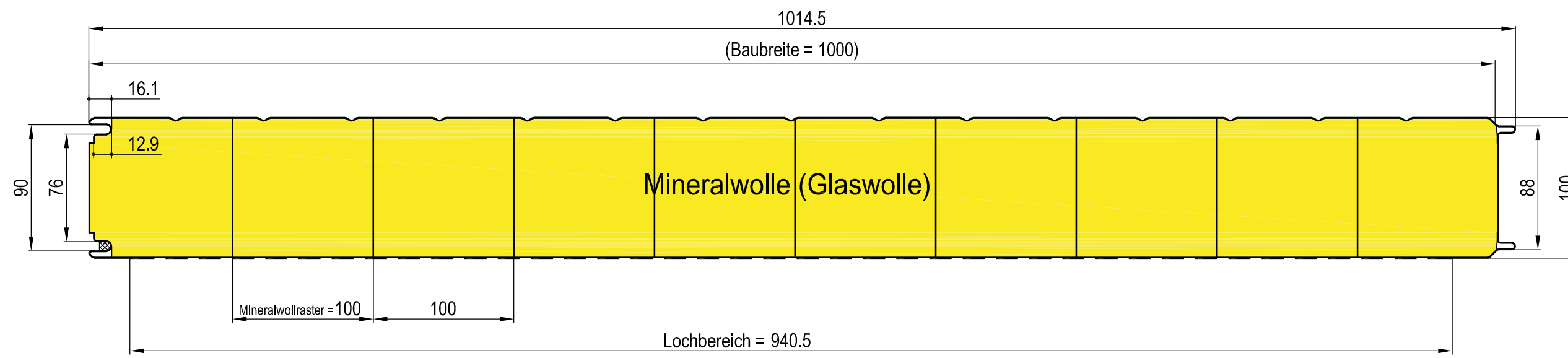

**Gesamtdicke: 120**

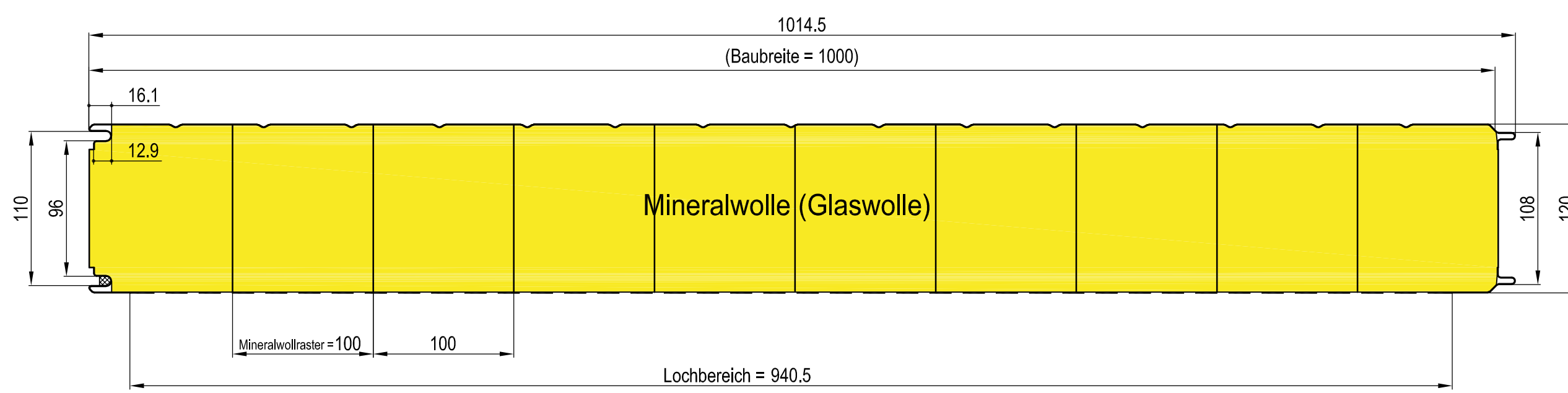

**Gesamtdicke: 150**

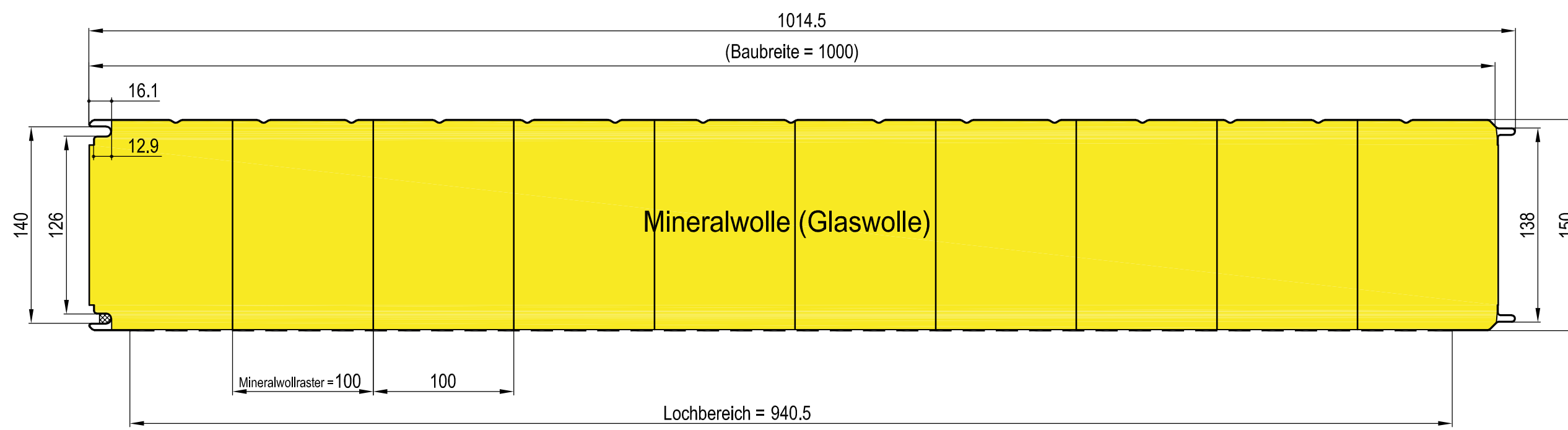

**Gesamtdicke: 200**

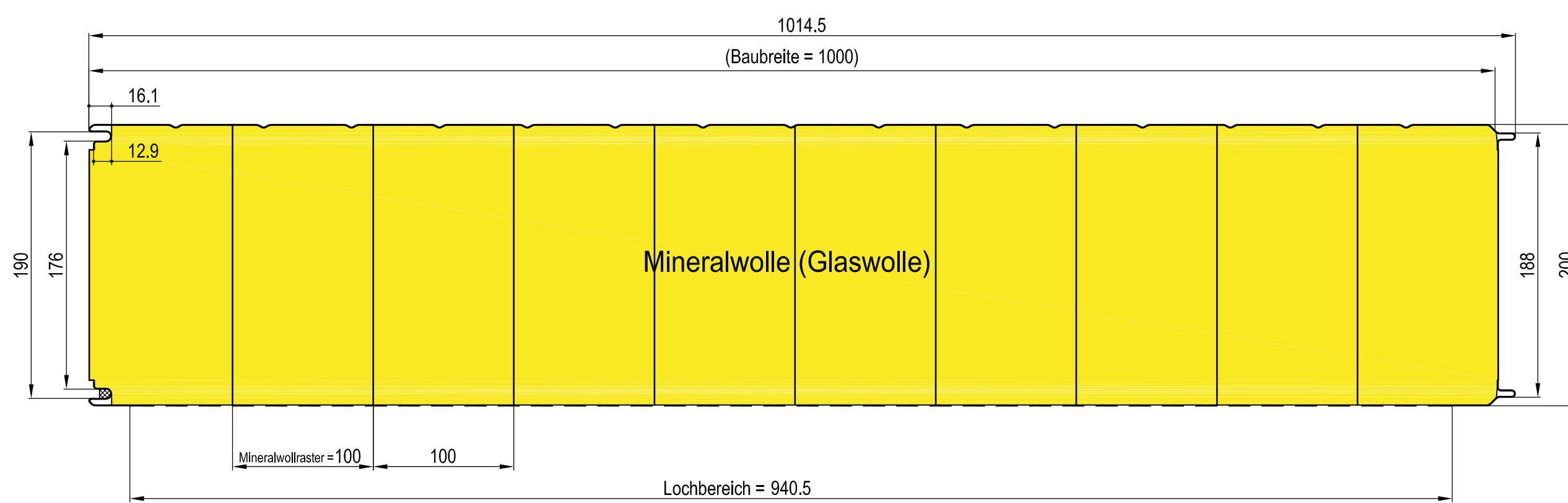

**Gesamtdicke: 240**

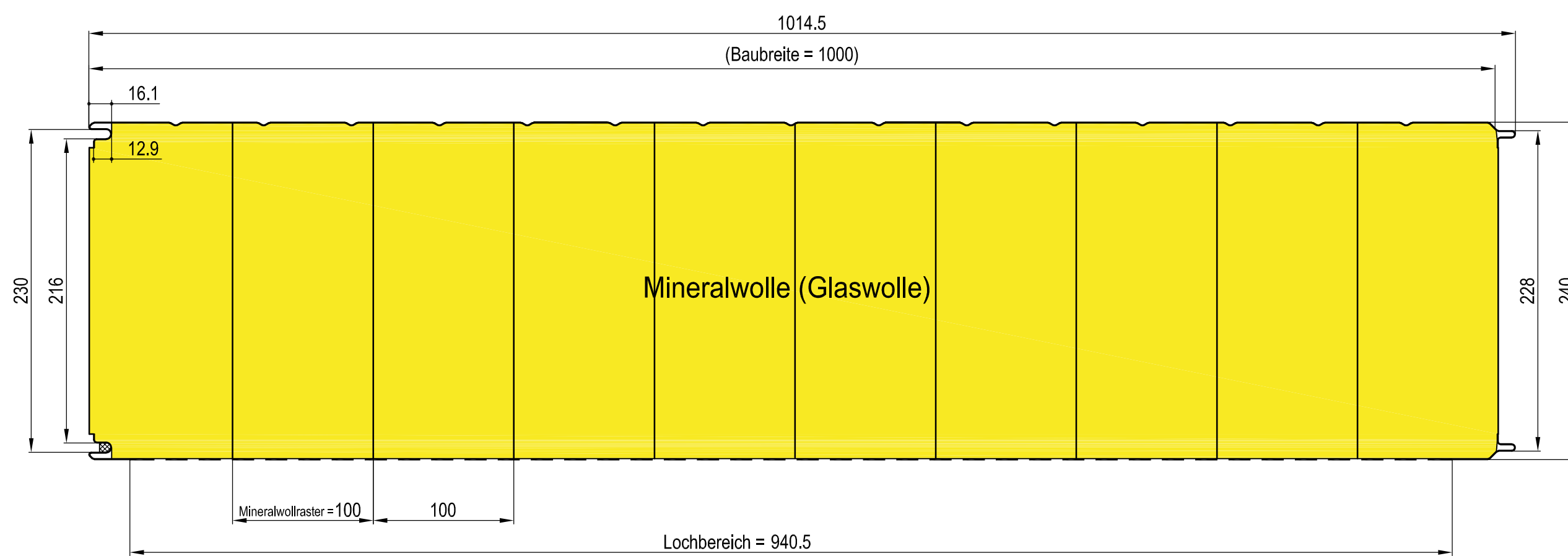

**Eben gelocht - PL-000**

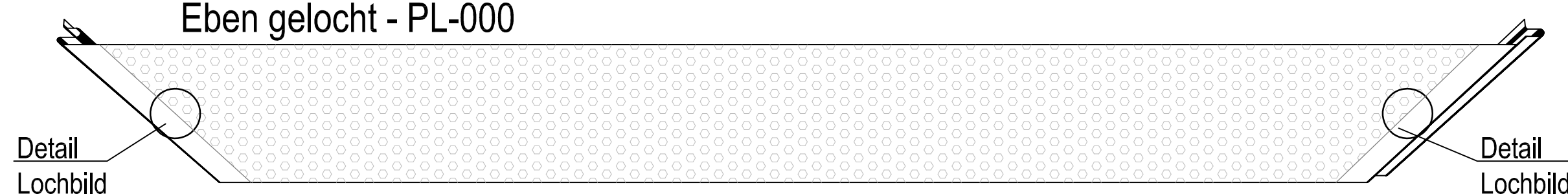

**Detail**

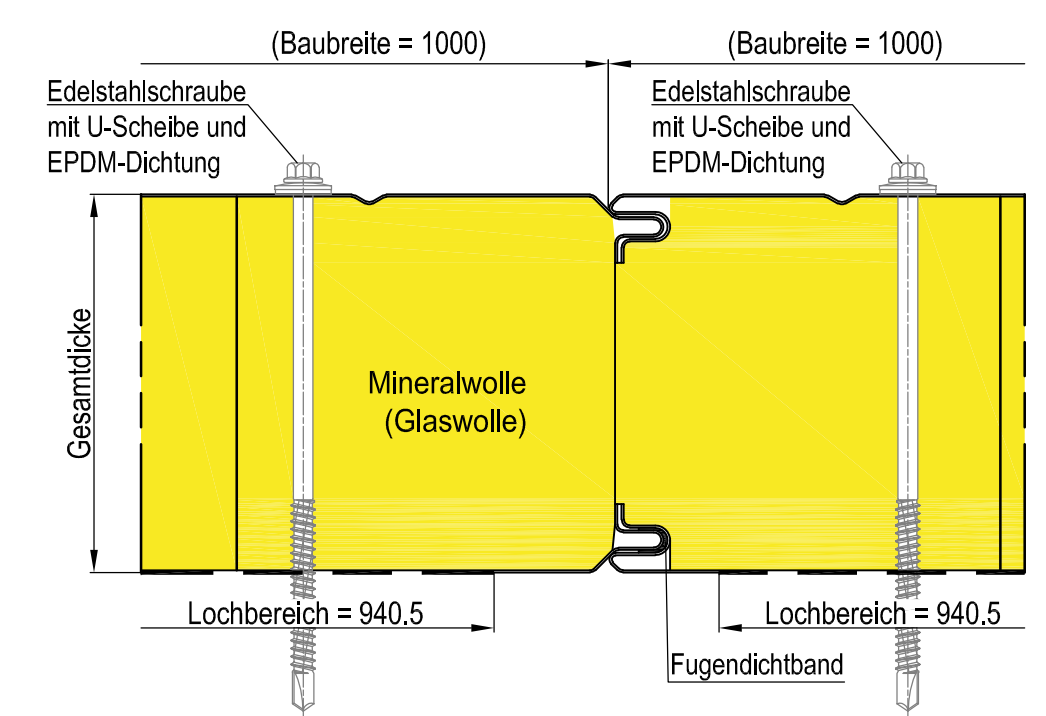

**Detail Lochbild**

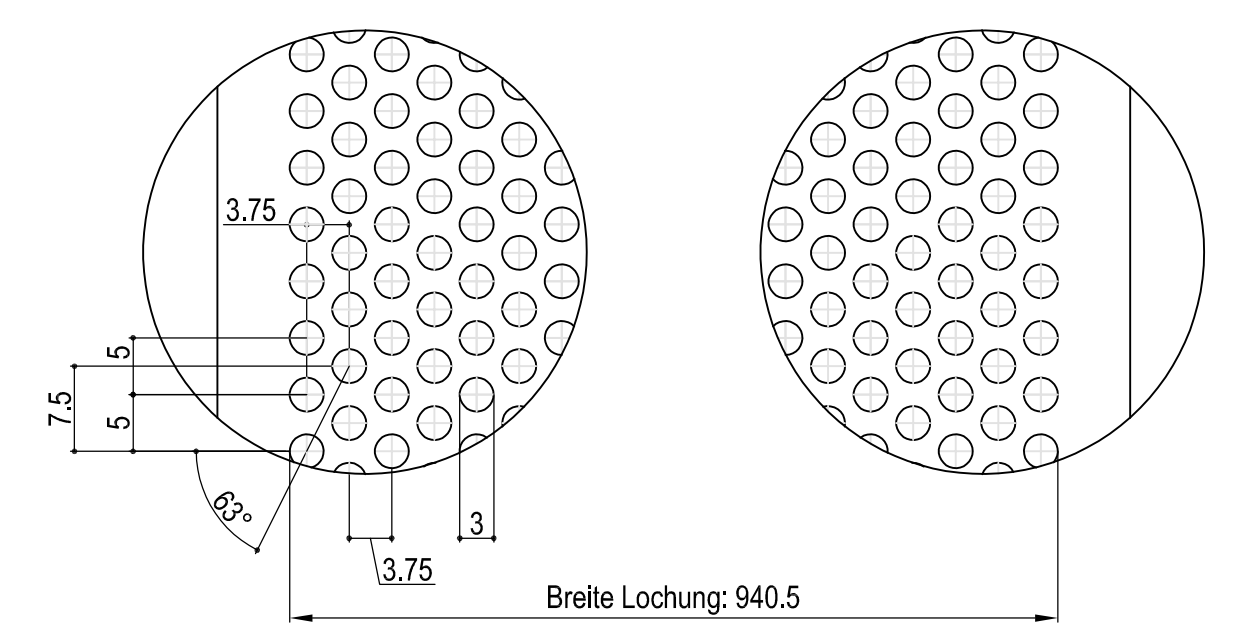

Es gelten die Toleranzen gemäß DIN EN 14509.

		Metecno Baustysteme GmbH		Maßstab	o. M.	Position	Menge
		Am Amselberg 1					
		99444 Blankenhain		Zeichnungs-Nr. 12-A			
01	Einheitsgröße 240mm ergibt	01.06.2017	ZB C.	Datum	Name	Metfiber® ECO Wand Sound	
				Bearb.	ZB Cramer	Sandwich - Wandelement mit Dämmkern aus	
				Freig.	Fr. Graf	Mineralwolle (Glaswolle)	
				Norm			
				zust. Sachbearbeiter:	R. Bräunel		
				<b>metecno</b>			
				Metecno Baustysteme GmbH			
Zust.	Änderung	Datum	Name				